

POWERTECH

Gate and garage doors solutions can Simplify your life,
stay connected to home and protect what matters most.



Powertech Automation Inc.

Address: 10F., No.100-1, Minquan Rd., Xindian Dist., New Taipei City 231, Taiwan (R.O.C.)

TEL: +886 2 86675222 FAX: +866 2 86675223 Email: sales@powertech.tw

Copyright © 2020 Powertech Automation Inc. All Rights Reserved.



POWERTECH
CATALOGUE

CONTENTS

About Powertech Automation

About Powertech Automation

Powertech Solution

Residential Application
Smart Wi-Fi Device - WBI

Automation For Swing Gates

PW530/530L
PW150/200
PW320 Series
PW330 Series

PAGE

05

07

09

13

15

17

19

Automation For Swing With Articulated Arms

PA250

Automation For Sliding Gates

PL500 SPEEDY/500
PL800
PL600/1000
PSA Series

Automation For Garage Doors

PG Series

IoT Solution

Eyeopen
Blitween
Biicam
Biibell

Accessories

Accessories

PAGE

21

25

27

29

31

35

37

39

41

43

47

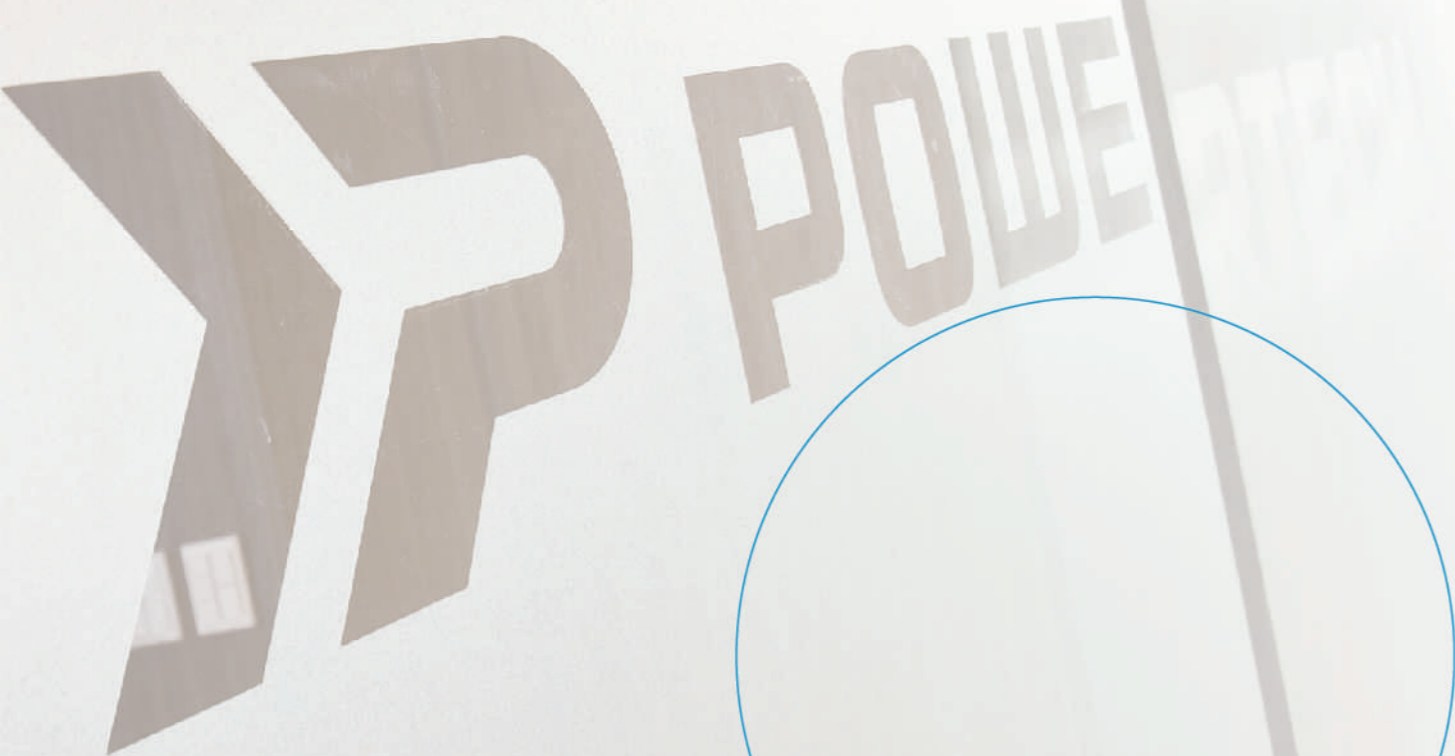

ABOUT

Powertech Automation Inc, Taiwan's leading manufacturer of gate openers, specializes in the design and manufacturing of total solutions in the field of gate and garage door automation for residential use.

With our expertise and continuous investment in R&D, we offer innovative, reliable, and simple-to-use products.

Our commitment to quality is our priority, as all of our production is certified by ISO 9001.

Our products bearing the CE mark have been tested in accordance with European requirements and with other internationally recognized standards.

Powertech Automation is now represented in more than 50 countries by partners who trust our company.

Our future mission is to improve everyday living environments with our innovative and value-adding solutions.

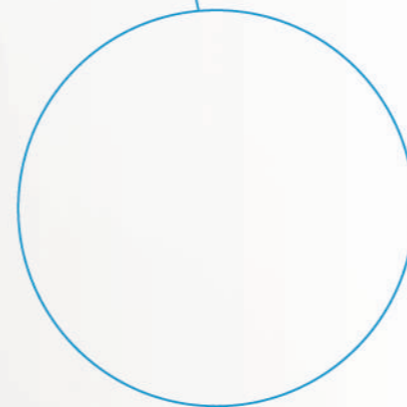

Our PHILOSOPHY

Customer Care

Powertech Automation offers to professionals, a wide range of quality and reliable motors and solutions. Our objective is to improve our customers' quality of life, this is why we design and manufacture highly functional, innovative and secure solutions for the gate automation industry.

Product Reliability

All of our products undergo very strict quality control and testing procedure to ensure their long term reliability and compliance with international standards. Powertech Automation is represented around the world by many partners in the industry who put trust and confidence in our brand name and in the quality of our solutions.

Research & Innovation

Passion in research for new solutions and optimization of the existing ones are the guidelines to our daily activities. We work to make our solutions a perfect fit to people needs and provide a more comfortable lifestyle. Our IoT solution, Eyeopen, allows our customers to simplify and have a wider choice of control on their home automation.



Take Control of Your Home



Monitor in real-time your gates and door through our integrated camera.



Operate all your doors even from far away from one single app.



Choose from a wide range of quality motors that can fit any gate requirements.



Receive real-time notifications on your phone once your doors open/close.



Manage your entrance with our video doorbell



Simplify the control on your gates via our smart Wi-Fi device

WB1

Smart Wi-Fi Device

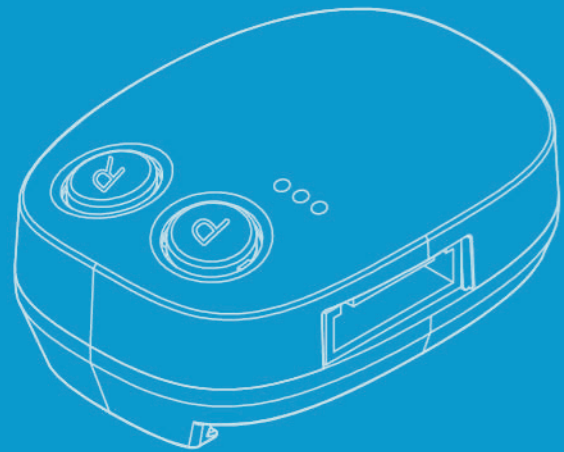

REDEFINING THE WAY TO OPEN YOUR GATE

Our smart Wi-Fi device – WB1 not only features an intuitive solution for the control of your gates but also provides the ideal solution for advanced management to professionals.

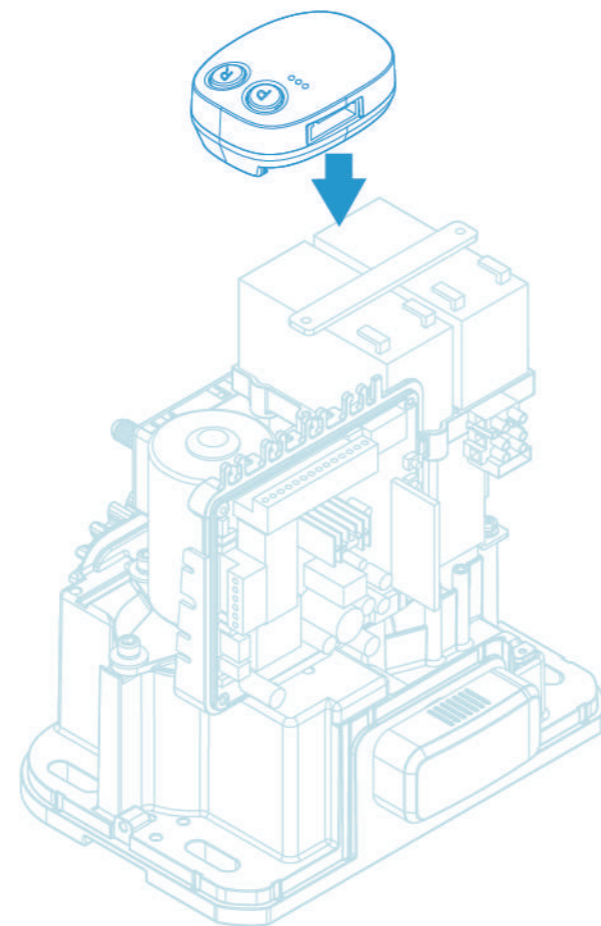

Features



Spare Key

The smartphone can work as digital key even without Wi-Fi connection to the gate opener. Customers did not have to worry about lost remote or Wi-Fi failure.



Data Management

Our data management platform keeps the device information which can help the installer to manage customer's records.



Wi-Fi Remote Control

Compatible with the Eyeopen App which allows you to control your gate openers with smartphone any time, anywhere.



Parameters

Ideal for installers to set up parameters and conduct maintenance without having to open the gate opener outer cover. All of the settings can be done through Eyeopen.



Warranty Period

The warranty period can be extended as it starts only once the WB1 has been activated.



SWING

PW

530/530L



Irreversible electromechanical 24Vdc geared motor for heavy applications

PW 530



Versatile, Reliable & Durable Over Time

- Designed for heavy swing gate with leaves up to 4.5m and 550kg
- Superior quality with die casting aluminum housing, resistant to atmospheric agents
- Embedded LED indicators for operation status

Practical & Easy To Operate

- Easy access to manual release handle from above
- Automatic memorization of limit switches on opening / closing by learning
- Adjustable opening and closing limit switches
- Back-up battery to ensure operation in case of power failure (optional)
- Large choice of programmable functions

Smartphone Control

- Control your gates through your smartphone anytime, anywhere
- Compatible with the Eyeopen App



Dimension PW530 & 530L

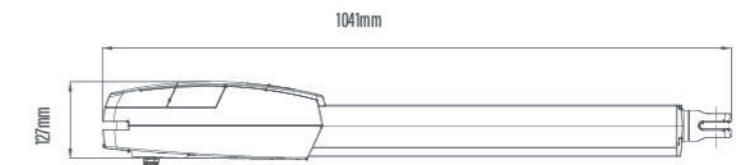
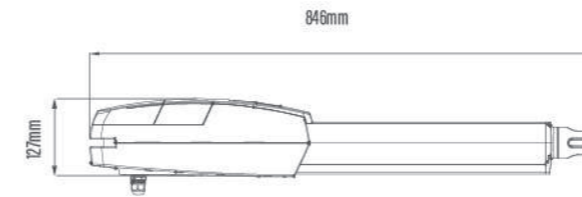

Utilisation Limits

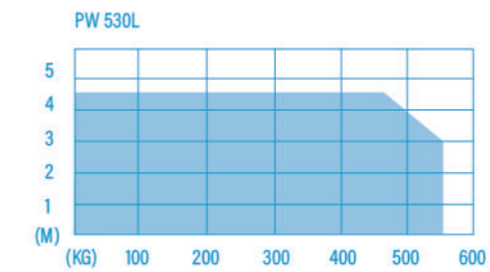
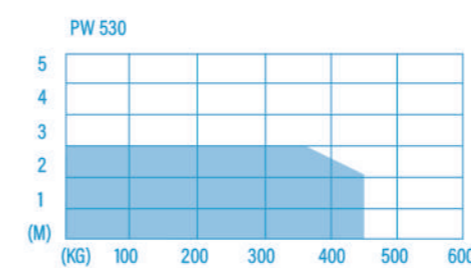

Technical Specifications

Model name	PW 530	PW 530L
Category	Swing Gate Opener	Swing Gate Opener
Max gate length	3M	4.5M
Max gate weight	450Kg	550Kg
Power Supply	110-240Vac (50-60Hz)	110-240Vac (50-60Hz)
Motor Power Supply	24Vdc	24Vdc
Gear type	Worm gear	Worm gear
Operation Stroke	350mm	540mm
Duty Cycle	20%	20%
IP Rating	IP44	IP44
Working temperature / Operating temperature	-20~50°C	-20~50°C
Current (A)	6A	6A
Power (W)	144W	144W
Release	Key	Key
Dimensions	846mm x 128mm x130mm	1041mm x 128mm x130mm



PW

150/200



Irreversible linear telescopic
24Vdc operator for
light residential gates

PW
200



Compact & Streamline Design For Light Gates

- Suited for light swing gates with leaves up to 2.5m and 250kg
- Easy and quick installation due to compact size, silent operation
- Motor located on the top for easy maintenance
- 2 options for front attachment : metal or plastic

Practical & Easy to Operate

- Two options available for auto-closing : time limit or photocell trigger
- Easy to operate release handle
- Back-up battery to ensure operation in case of power failure (optional)
- Large choice of programmable functions

Smartphone Control

- Control your gates through your smartphone anytime, anywhere
- Compatible with the Eyeopen App



Dimension PW150 & 200

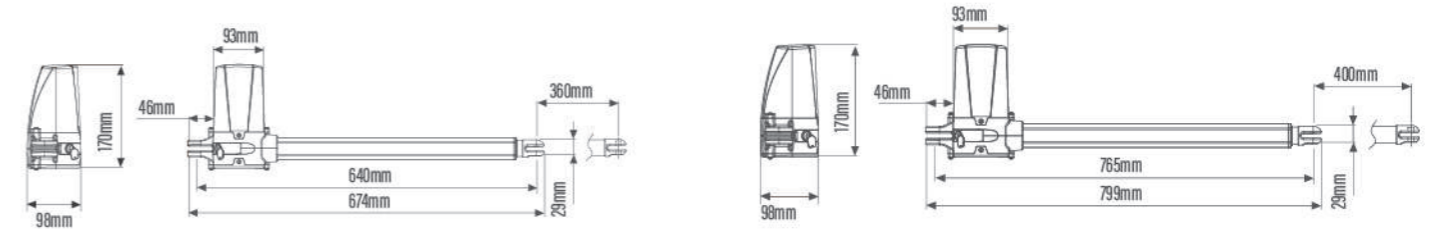

Utilisation Limits

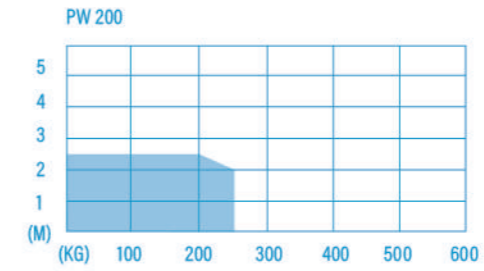
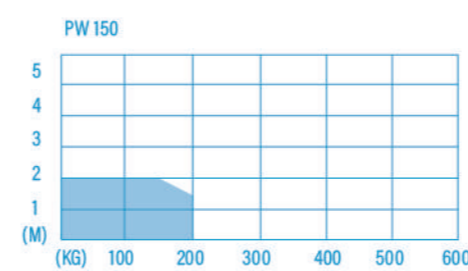

Technical Specifications

Model name	PW150	PW200
Category	Swing Gate Opener	Swing Gate Opener
Max gate length	2M	2.5M
Max gate weight	200Kg	250Kg
Power Supply	110-240Vac (50-60Hz)	110-240Vac (50-60Hz)
Motor Power Supply	24Vdc	24Vdc
Gear type	Worm gear	Worm gear
Operation Stroke	360mm	400mm
Duty Cycle	20%	20%
IP Rating	IP44	IP44
Working temperature / Operating temperature	-20~50°C	-20~50°C
Current (A)	4.2A	4.2A
Power (W)	100W	100W
Release	Key	Key
Dimensions	674mm x 98mm x 170mm	799mm x 98mm x 170mm



PW

320 Series

(Model no. PW220/220K/320/320K)



Irreversible
electromechanical 24Vdc
geared motor
for residential gates

PW
320



Reliability & Durability Over Time

- Designed for swing gates with leaves up to 3.0m and 300kg
- Superior quality building with matte finishing provides additional protection from rust
- Offer stable force output through the linear motor design
- Easy installation with a wide range of angle

Practical & Easy to Operate

- Two options for release device : tools or keys
- Large choice of programmable functions
- Back-up battery in case of power failure (optional)

Smartphone Control

- Control your gates through your smartphone anytime, anywhere
- Compatible with the Eyeopen App



Dimension PW220 / 220K & 320 / 320K

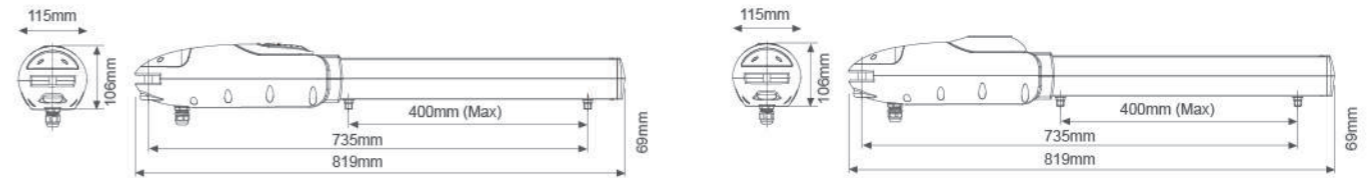

Utilisation Limits

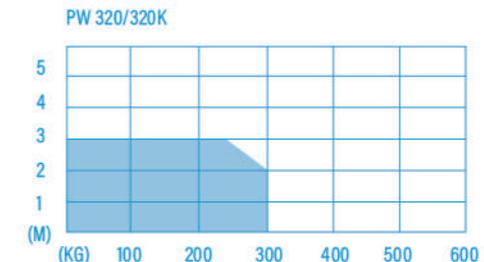
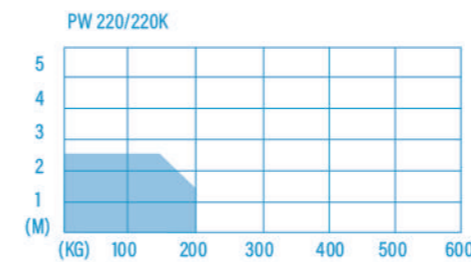

Technical Specifications

Model name	PW 220 / 220K	PW 320 / 320K
Category	Swing Gate Opener	Swing Gate Opener
Max gate length	2.5M	3M
Max gate weight	200Kg	300Kg
Power Supply	110-240Vac (50-60Hz)	110-240Vac (50-60Hz)
Motor Power Supply	24Vdc	24Vdc
Gear type	Worm gear	Worm gear
Operation Stroke	350mm	350mm
Duty Cycle	20%	20%
IP Rating	IP44	IP44
Working temperature / Operating temperature	-20~50°C	-20~50°C
Current (A)	4A	6A
Power (W)	100W	144W
Release	Tool or Key	Tool or Key
Dimensions	844mm x 115mm x 106mm	844mm x 115mm x 106mm



PW

330 Series

(Model no. PW230/230K /330/330K/330L)



Irreversible
electromechanical
24Vdc geared motor
for multiple applications



Practical & Quick Installation

- Designed for swing gates with leaves up to 4.5M and 450kg
- Suited for heavy gates application with increased durability
- Easy installation with a wide range of angle

Smartphone Control

- Control your gates through your smartphone anytime, anywhere
- Compatible with the Eyeopen App



Safe & Easy To Operate

- Easy access to manual release handle from above
- Deceleration on opening and closing for more safety
- Back-up battery in case of power failure (optional)
- Large choice of programmable functions

Dimension PW230 / 230K / 330 / 330K & 330L

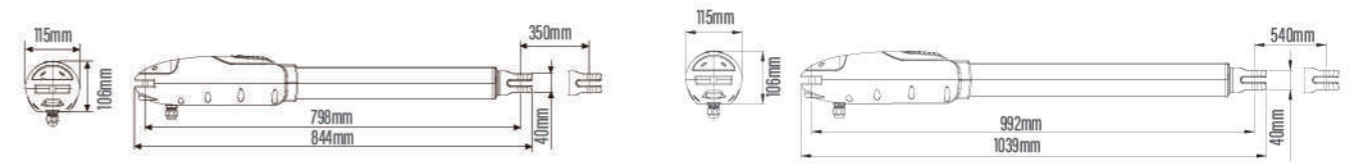

Utilisation Limits

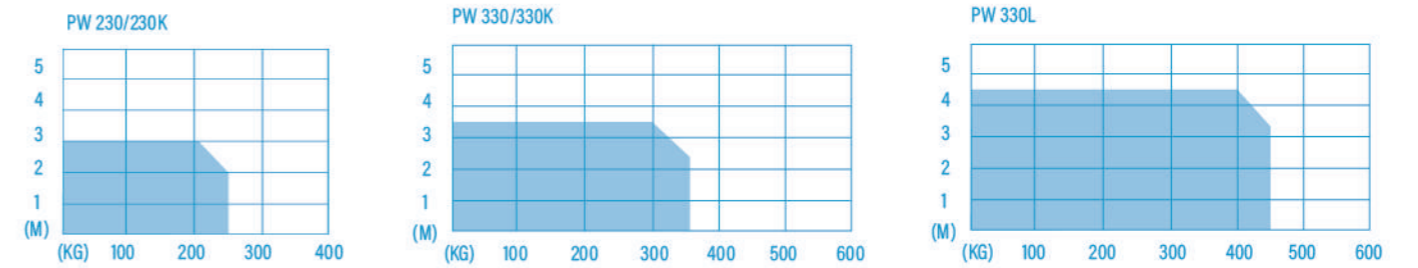

Technical Specifications

Model name	PW 230 / 230K	PW 330 / PW 330K	PW 330L
Category	Swing Gate Opener	Swing Gate Opener	Swing Gate Opener
Max gate length	3M	3.5M	4.5M
Max gate weight	250Kg	350Kg	450Kg
Power Supply	110-240Vac (50-60Hz)	110-240Vac (50-60Hz)	110-240Vac (50-60Hz)
Motor Power Supply	24Vdc	24Vdc	24Vdc
Gear type	Worm gear	Worm gear	Worm gear
Operation Stroke	350mm	350mm	540mm
Duty Cycle	20%	20%	20%
IP Rating	IP44	IP44	IP44
Working temperature / Operating temperature	-20~50°C	-20~50°C	-20~50°C
Current (A)	4.2A	6A	6A
Power (W)	100W	144W	144W
Release	Tool or Key	Tool or Key	Tool or Key
Dimensions	84.4mm x 115mm x 106mm	84.4mm x 115mm x 106mm	105.9mm x 123mm x 124mm



PA 250



Irreversible
electromechanical
24Vdc geared motor
with articulated arms



Reliable & Durable

- Design for swing gates with leaves up to 2.5m and 250kg
- Suitable for gates installed on large posts
- Manufactured with high quality materials for greater reliability
- Built-in control unit with plastic enclosure to protect against dust and insects

Smartphone Control

- Control your gates through your smartphone anytime, anywhere
- Compatible with the Eyeopen App



Safe & Easy To Operate

- Simple and precise limit switch adjustment
- Easy to operate release handle
- Back-up battery to ensure operation in case of power failure (optional)
- Large choice of programmable functions

Dimension PA250

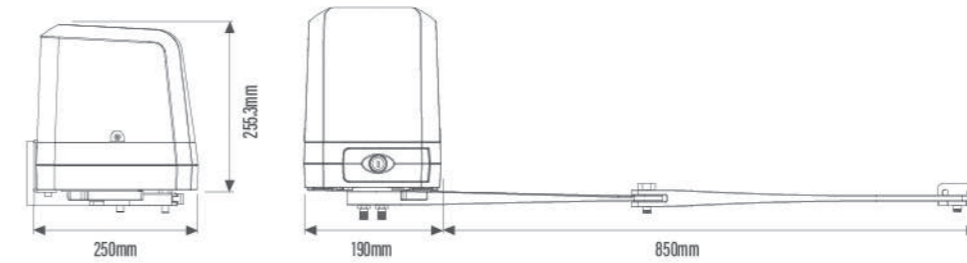

Utilisation Limits

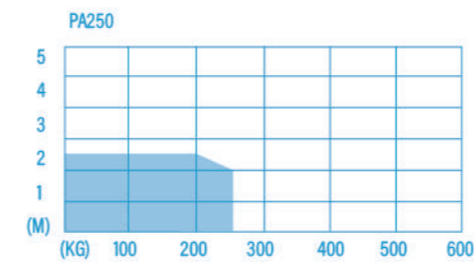

Technical Specifications

Model name	PA 250
Category	Articulated Arm Opener
Max gate length	2.5M
Max gate weight	250kg
Power Supply	110-240Vac (50-60Hz)
Motor Power Supply	24Vdc
Gear type	Worm gear
Operation Stroke	-----
Duty Cycle	20%
IP Rating	IP44
Working temperature / Operating temperature	-20~50°C
Current (A)	6A
Power (W)	144W
Release	Key
Dimensions	256mm x 187mm x 267mm



A blue-tinted photograph of a sliding gate in front of a wooden building, with the word "SLIDING" overlaid in white text. The gate is partially open, revealing a paved area and a wooden structure in the background. The image is set against a dark blue background with a subtle geometric pattern of overlapping triangles.

SLIDING

NEW

PL 500 SPEEDY



Designed for high speed automation sliding gates weighing up to 500kg

PL
500
SPEEDY



SPEEDY
DRIVING
GEAR

Quality High-Speed Automation

- Designed for sliding gates weighing up to 500kg
- Class leading speed up to 0.33m/s
- Enhanced durability with die casting aluminum base
- Single-piece cover resistant to atmospheric agents

Smartphone Control

- Control your gates through your smartphone anytime, anywhere
- Compatible with the Eyeopen App



Practical & Easy To Operate

- Built-in control unit with LED display for easy configuration
- Back-up battery to ensure operation in case of power failure (optional)
- Large choice of programmable functions

Dimension PL500 Speedy / 500

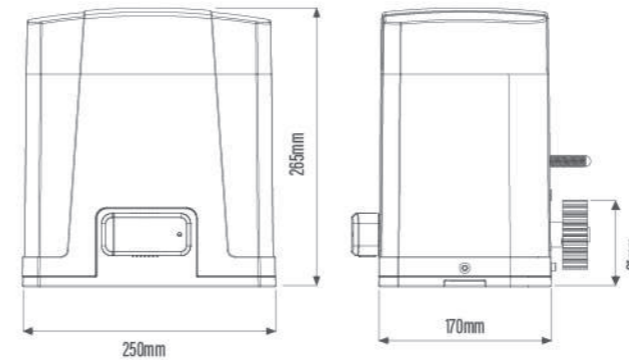

Utilisation Limits

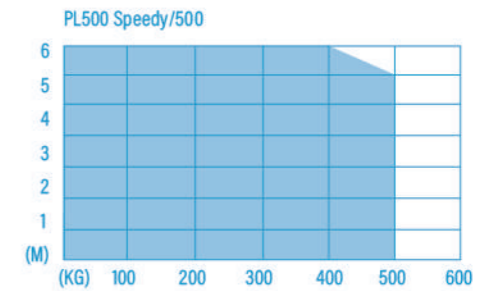

Technical Specifications

Model name	PL 500 speedy	PL 500
Category	Sliding Gate Opener	Sliding Gate Opener
Max gate length	6M	6M
Max gate weight	500Kg	500kg
Power Supply	110-240Vac (50-60Hz)	110-240Vac (50-60Hz)
Motor Power Supply	12V / 24V	12V/24V
Gear type	Worm gear	Worm gear
Duty Cycle	20%	20%
IP Rating	IP44	IP44
Working temperature / Operating temperature	-20~50°C	-20~50°C
Current (A)	4.2A	4.2A
Power (W)	100W	100W
Release	Key	Key
Dimensions	250mm x170mm x265mm	250mm x 170mm x265mm



PL 800



Irreversible
24Vdc operator
for heavy sliding gates



Compact, Yet Powerful

- Designed for sliding gates weighing up to 800kg
- Enhanced durability with die casting aluminum base
- Single-piece cover resistant to atmospheric agents

Smartphone Control

- Control your gates through your smartphone anytime, anywhere
- Compatible with the Eyeopen App



Practical & Easy To Operate

- Built-in control unit with LED display for easy configuration
- Back-up battery to ensure operation in case of power failure (optional)
- Large choice of programmable functions

Dimension PL800

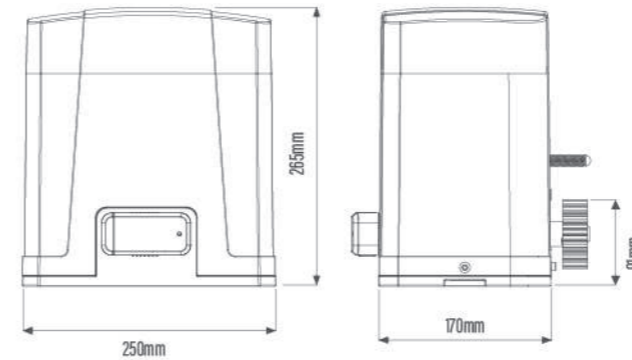

Utilisation Limits

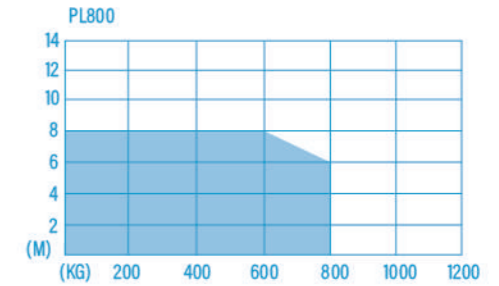

Technical Specifications

Model name	PL 800
Category	Sliding Gate Opener
Max gate length	8M
Max gate weight	800Kg
Power Supply	110-240Vac (50-60Hz)
Motor Power Supply	12V / 24V
Gear type	Worm gear
Duty Cycle	20%
IP Rating	IP44
Working temperature / Operating temperature	-20~50 °C
Current (A)	6A
Power (W)	144W
Release	Key
Dimensions	250mm x 170mm x 265mm



PL 600/1000



Irreversible
24Vdc operator
for sliding gates



Powerful, Robust & Reliable

- High performance operator designed for sliding gates up to 1000kg
- Waterproof, scratch resistant, and UV protected enclosure for increased durability
- Suited for heavy gates application

Smartphone Control

- Control your gates through your smartphone anytime, anywhere
- Compatible with the Eyeopen App



Practical & Easy To Operate

- Built-in control unit that features adjustable speed and force output
- Manual release handle, resistant to atmospheric agents
- Back-up battery in case of power failure(optional)

Dimension PL600 / 1000

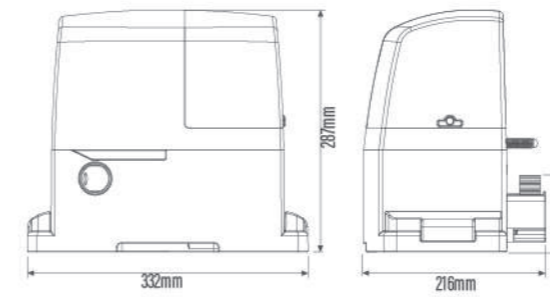

Utilisation Limits

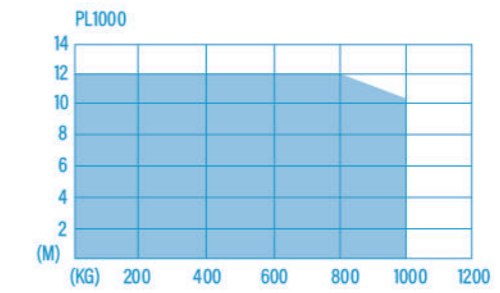
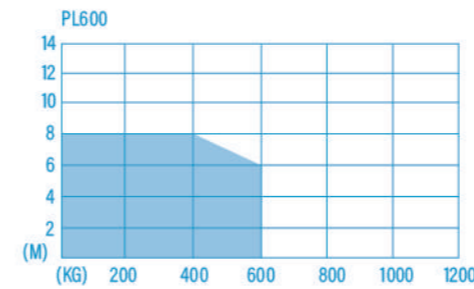

Technical Specifications

Model name	PL 600	PL 1000
Category	Sliding Gate Opener	Sliding Gate Opener
Max gate length	8M	12M
Max gate weight	600Kg	1000Kg
Power Supply	110-240Vac (50-60Hz)	110-240Vac (50-60Hz)
Motor Power Supply	24V	24V
Force	6500N	10500N
Gear type	Worm gear	Worm gear
Duty Cycle	20%	20%
IP Rating	IP44	IP44
Working temperature / Operating temperature	-20~50°C	-20~50°C
Current (A)	6A	6A
Power (W)	144W	144W
Release	Key	Key
Dimensions	333mm x 216mm x 287mm	333mm x 216mm x 287mm

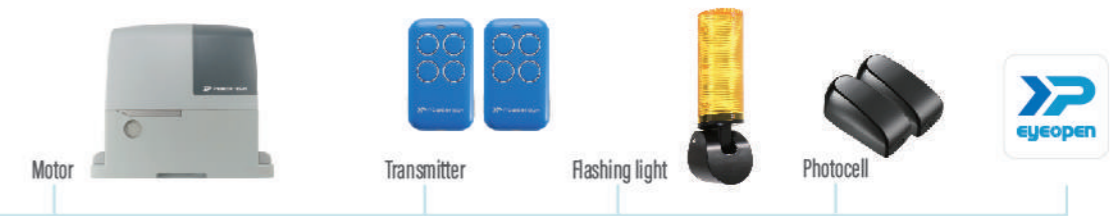

PSA Series

(Model no. PSA700/1200/1500)



Irreversible
230Vac operator
for sliding gates
weighing up to 1500kg

PSA
1500



Dimension PSA700 / 1200 / 1500

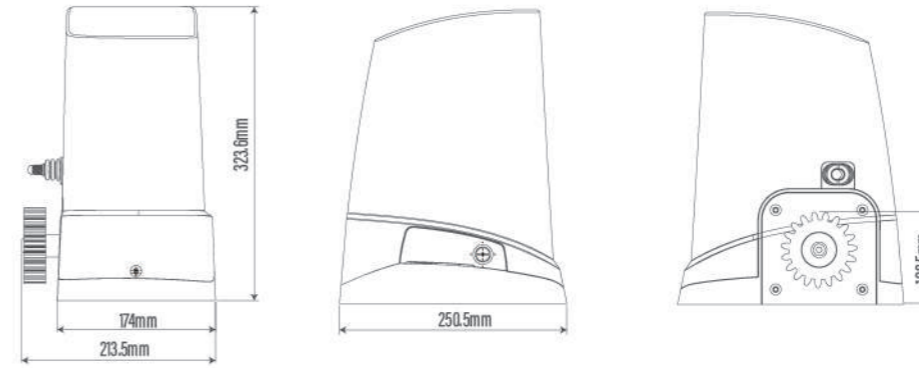

Utilisation Limits

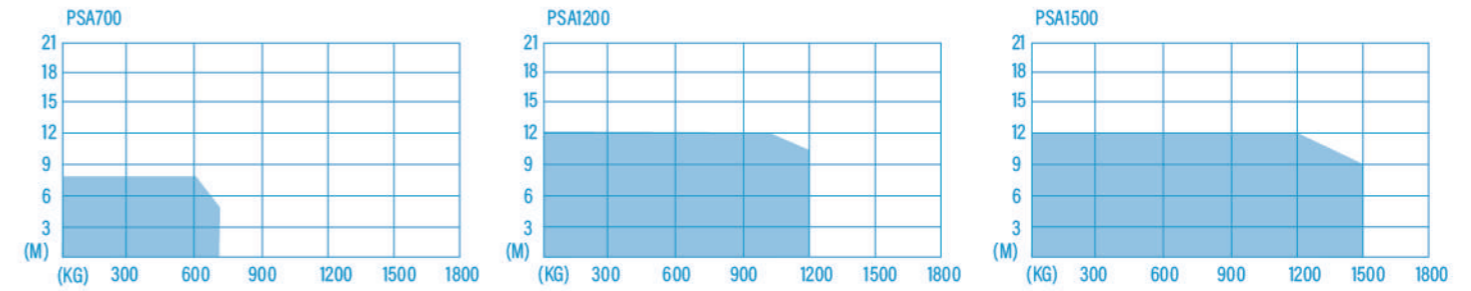

Technical Specifications

Model name	PSA 700	PSA 1200	PSA 1500
Category	AC Sliding Gate Opener	AC Sliding Gate Opener	AC Sliding Gate Opener
Max gate length	8M	12M	12M
Max gate weight	700Kg	1200Kg	1500Kg
Power Supply	AC230V 50Hz	AC230V 50Hz	AC230V 50Hz
Gear type	Worm gear	Worm gear	Worm gear
Duty Cycle	20%	20%	20%
IP Rating	IP54	IP54	IP54
Working temperature / Operating temperature	-20~50°C	-20~50°C	-20~50°C
Current (A)	1.48A	1.85A	1.85A
Power (W)	340W	425W	425W
Release	Key	Key	Key
Dimensions	250mm 174mm x323mm	250mm x 174mm x323mm	250mm x 174mm x323mm

Streamline, Compact & Powerful

- Designed for sliding gates weighing up to 1500kg
- 230Vac operator for intensive use and heavy gate applications
- Compact and streamline design
- Single-piece cover resistant to atmospheric agents

Smartphone Control

- Control your gates through your smartphone anytime, anywhere
- Compatible with the Eyeopen App

Practical & Easy To Operate

- Built in control unit
- Easy access to release handle
- Large choice of programmable functions





GARAGE DOOR

PG Series

(Model no. PG60/80/100/120)



Adapted for all garage doors type
One solution for a wide range of garage doors

PG 100



Dimension PG 60 / 80 / 100 / 120

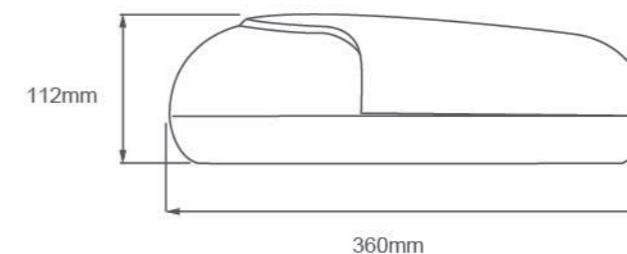

Technical Specifications

Model name	PG 60	PG 80	PG 100	PG 120
Category	DC Garage Door Motor	DC Garage Door Motor	DC Garage Door Motor	DC Garage Door Motor
Max gate length / Max gate weight	8-10m ²	10-12m ²	12-14m ²	14-16m ²
Power Supply	AC 220 / 110V ; 50Hz~60Hz	AC 220 / 110V ; 50Hz~60Hz	AC 220 / 110V ; 50Hz~60Hz	AC 220 / 110V ; 50Hz~60Hz
Motor Power Supply	DC24V	DC24V	DC24V	DC24V
Gear type	Worm gear	Worm gear	Worm gear	Worm gear
Force	600N	800N	1000N	1200N
Duty Cycle	20%	20%	20%	20%
IP Rating	IP44	IP44	IP44	IP44
Working temperature / Operating temperature	-20~50°C	-20~50°C	-20~50°C	-20~50°C
Current (A)	3.08A	3.33A	4.17A	5A
Power (W)	72W	80W	100W	120 W
Manual release	Yes	Yes	Yes	Yes
Enclosure Dimensions	360mmx228mm x115mm	360mmx228mm x115mm	360mmx228mm x115mm	360mmx228mm x115mm

Adaptable Solution For A Wide Range Of Garage Doors

- Designed for garage door automation up to 16m²
- Smooth and silent operation
- Two rail options available: chain or belt driven

Smartphone Control

- Control your gates through your smartphone anytime, anywhere
- Compatible with the Eyeopen App



Reliable Functions

- Built in control unit with LED display for easy set up
- Built in LED courtesy light
- Back-up battery in case of power failure
- Large choice of programmable functions



eyeopen

NO MATTER WHERE YOU ARE YOU ARE **ALWAYS AT HOME.**



Eyeopen centralizes all Powertech Automation gate openers and IoT Devices on one single application. Our intuitive interface combines convenience, comfort and safety. It allows you to manage and monitor in real-time your entrances, remotely operate your gates, and much more...



Custom settings are available for a number of parameters.
Get alerts on your smartphone when the gate/door opens, closes or is left open.
Managing your connected automation on-site or remotely with ease.



Biitween NEW

Connecting all possibilities.

With Biitween, you can upgrade all your gates to Wi-Fi enabled smart and have simple controls on one single APP- Eyeopen.



- ✓ **Great Compatibility**
- ✓ **Push Notification**
- ✓ **Remote Control**
- ✓ **Authorize multi-user**

Technical data

Frequency	433 Mhz and 2.4GHz
Operation Temperature	-30~70°C
Dimensions	56mm x110mm x35mm
Power	AC/DC, 12V/24V, 1A



GREAT COMPATIBILITY

Compatible with most Italian/European gate opener brands

CONTROL WITH Wi-Fi OR RF TRANSMITTER

Biitween allows you to control the gate via your smartphone or the Powertech remote control depending on your preference.



SHARE ACCESS

Biitween comes with 10 free users. The owner can assign different levels of access authority to others based on their demands.

3 DOOR SUPPORTED

Biitween can connect with up to 3 doors and easily operate all of the home accesses on one APP.

BiiCam

FULL HD
1080p

NEW

1080P outdoor camera for your safety

- ✓  Privacy Mask
- ✓  Wi-fi
- ✓  Motion Detection
- ✓  IP 66
- ✓  Night Vision



Technical data

Video Resolution	Full HD 1080P
Compression	H.264
Frame Rate	25fps
Field of View	95°
Day/Night Mode	ICR with IR LED
Connectivity	802.11b/g/n@2.4GHz
Ethernet	10/100Mbps
Alarm	Motion Detection
Storage	Micro SD card up to 128GB (SD card not include)
Record Mode	Event
Waterproof	IP66
Operation Temperature	-30~60°C
Power	Power adapter DC12V/1A



REAL-TIME SECURITY SYSTEMS

Secure your home with our integrated camera available with Eyeopen App.

MOTION DETECTION RECORDING

Increase your safety as the camera will automatically record and store videos in the microSD card.



CONCEAL PARTS OF THE IMAGE

The privacy mask feature allows IP cameras to block out sensitive area to protect personal privacy and comply with local regulations.

NIGHT VISION

Built-in high performance IR LED provides illumination up to 20m distance at night

Biibell

FULL HD
1080p

NEW

Smart security starts at the front door

- ✓ +  2 Way Audio
- ✓  Notification
- ✓  Easy Installation
- ✓  Motion Detection



Technical data

Video Resolution	Full HD 1080P
Field of View	150 Degree
Compression	H.264
Frame Rate	25fps
Day/Night Mode	ICR with IR LED
Audio	2 Way Audio
Connectivity	802.11b/g/n@2.4G
Ethernet	10/100Mbps
Storage	MicroSD card up to 128GB
Waterproof	IP44
PIR Detection	110 Degree
Tamper Alarm	Support
Power Supply	DC 9V~36V; AC 8V~24V; PoE
Operate Temperature	-20 ~55°C



MORE THAN A SIMPLE DOORBELL

Check in anytime on what's happening outside your home.

TWO-WAY AUDIO

Answer your door from anywhere.

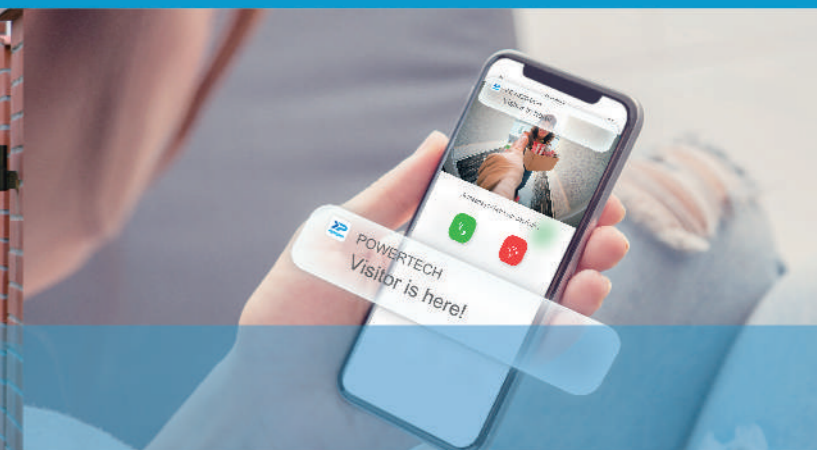

MOTION DETECTION

Receive a real-time notification on your smartphone when someone triggers the built-in motion sensor.

PUSH NOTIFICATIONS

Automatically sends notification when visitors press the doorbell.



ACCESSORIES

T

TRANSMITTER



Transmitter 4 Channel R1-009

Model: 4 Channel Transmitter
 Frequency: 433.92Mhz
 Estimated Range: 100 meters

Operating Temperature: -20° ~ 60°C
 Dimensions: 66x39x13mm
 IP Ratings: IPX44



Transmitter 4 Channel PR-4

Model: 4 Channel Transmitter
 Frequency: 433.92Mhz
 Estimated Range: 100 meters

Operating Temperature: -20° ~ 60°C
 Dimensions: 80x40x20mm



Transmitter 4 Channel PR-2

Model: 4 Channel Transmitter
 Frequency: 433.92Mhz
 Estimated Range: 100 meters

Operating Temperature: -20° ~ 60°C
 Dimensions: 106x53x20mm



Transmitter 2 Channel PR-1

Model: 2 Channel Transmitter
 Frequency: 433.92Mhz
 Estimated Range: 100 meters

Operating Temperature: -20° ~ 60°C
 Dimensions: 72x33x14mm

P

PHOTOCELLS



PH-6

Power Supply: 12-24V DC
 Frequency: 433.92Mhz
 Estimated Range: 20 meters

IP Ratings: IP44
 Operation Indicator: Red Led (RX): Beam interrupted
 Green LED (TX) Beam aligned

RECEIVER BOX



PRB-1

Power Supply: 12-24V DC
 Frequency: 433.92Mhz
 Estimated Range: 50 meters

Dimensions: 106x53x20mm
 IP Ratings: IP54

RACK



Nylon Rack

Material: Nylon
 Dimensions: 1 meter



Metal Rack

Material: Metal
 Dimensions: 1 meter

R

KEYPAD / KEY SELECTOR



Wireless Keypad KP-1

Model: Wireless Keypad
 Frequency: 433.92Mhz +/- 75kHz
 Estimated Range: 50 meters

Dimensions: 85x75x35mm
 IP Ratings: IP54



Key Selector PKS-1

Model: Key selector
 Operating Temperature: -20° ~ 50°C

IP Ratings: IP54

K

B BATTERY



Battery For Swing Gate

Application Swing gate
Voltage 12V / 2.2Ax2pc

Dimensions 70x47x103mm



Battery For Sliding Gate

Application Sliding gate
Voltage 12V / 1.3Ax2pc

Dimensions 98x44x58mm

P PUSH BUTTON



Push Button PPB-1

Operating Temperature -20° ~ 50°C

Dimensions 85x61x40mm



Wireless Push Button PPB-2

Operating Temperature -20° ~ 50°C

Dimensions 85x61x40mm

F FLASHING LIGHT



Flashing Light PF-1

Power Supply 12-24V DC
Installation Vertical or horizontal
Antenna Built-in

Operating Temperature -20° ~ 50°C
Dimensions 205x80x75mm